

Comfort, Lite 2, Mediatic

INSTRUCTIONS FOR USE



**IMPORTANT -
READ CAREFULLY AND RETAIN FOR FUTURE REFERENCE**

March 2024

Contents

01 General Safety

General Safety	06
General Warnings	07
Specific Warnings	08

02 Introduction

Introduction	11
--------------	----

03 Product Description

Product Description	12
---------------------	----

04 Clinical Applications

Intended Use	14
Indications (Appropriate for):	14
Contra-Indications (Not appropriate for):	15
Posture	15
Size	15

05 Before Use

Before Use	16
------------	----

06 Before Use Checks

Before Use Checks	17
-------------------	----

07 Operation

Using the Castor Brakes	18
Chair Positions	19
Hand Controls	20
Changing Chair Positions	21
Changing the Angle of the Backrest	22
Locking out the Hand Control	22

08 Chair Adjustments

Backrest Position / Seat Depth Adjustment	23
Chair Height Adjustment	23
Using other Mobility Aids with the Chair	24
Sliding the Armrests	24
Reversing the Armrests	25
Seat Overlay Options	25
Fitting / Adjusting Backrest Pillows	25
Pillow Filling Adjustment	26
Adjustment of the Rise Position Angle	26
Hand Control Location Options	27

09 Using Battery System

To Use Battery Operated Reset System	28
To Use Li-ion Battery for General Use	28

10 Accessories

Depth Adjustment Kit	29
Height Adjustment Kit	29
Lateral Supports	30
Lateral Support Backrest	30
Adjustable Lateral Support Backrest	31
Profiled Headrest	31
Channel Legrest	32
Two Button Hand Control	32

11 Product Care

General Maintenance	33
Daily Maintenance	34

12 Decontamination

Cleaning Instructions	35
Metal Frame	35
Disinfection	35
Fabric and Covers	36

13 Storage and Transport

Storage	37
Transporting the Chair	37
Disassembly Information	37

14 Product Disposal

Product Disposal	38
------------------	----

15 Troubleshooting

Troubleshooting	39
-----------------	----

16 Technical Specification

Model Numbers	41
Technical Data	43
Dimensions	45
Chair Weights	46
Seat Angles - All Models	47
Symbols	48

17 Guarantee

Guarantee	49
-----------	----

18 Regulation & Standards

Standards	49
-----------	----

19 Contact Details

Contact Details	49
-----------------	----

Design Policy & Copyright

® and ™ are trademarks belonging to Accora Ltd unless otherwise stated. As our policy is one of continuous improvement, we reserve the right to modify designs without prior notice. © Accora Ltd 2024.

Welcome

Dear Customer,

Thank you for purchasing an Accora healthcare product. Before operating the product, you must read and understand all the instructions in this manual. All actions and handling of the product must be performed in accordance with the instructions in this manual.

Please ensure that the manual is available to users and operators throughout the product's service life.

If you need further information, please contact us at:

Tel: 01223 206100

E-mail: info@accora.care

01 General Safety

General Safety

The Configura® Comfort 1, Lite 2 and Mediatric Chairs are classified as a Class1 Medical Device in accordance with the Medical Devices Regulation 2002 as amended and the Medical Device Regulation 2017/745.



Notice to User

If a serious incident occurs in relation to this medical device, affecting the user or the patient, then the user or patient should report the serious incident to the medical device manufacturer (or distributor) and, in the European Union, the user should also report the serious incident to the Competent Authority in the member state where they are located.



Accora Ltd, 38 Main Street,
Swords, Co. Dublin, Ireland, K67 E0A2
T: +353 (0)1 695 0614

The serial number and date of manufacture of this product are shown on the chair frame. Please record them and quote when ordering spare parts.

Accora Ltd is committed to deliver safe products to its customers and has a policy of continuous improvement.

You may see the following terms used in this document:

WARNING:

- **This is a statement that alerts the user to the possibility of injury, death or other serious adverse reactions associated with the use or misuse of the product.**

 CAUTION:

- This is a statement that alerts the user to the possibility of a problem with the product associated with its use or misuse. Such problems include product malfunction, product failure, damage to the product or damage to other property.

General Warnings

 WARNING:

- This is an electrical item and should be treated with caution.
- Always ensure that there is nothing to obstruct the free movement of the chair, for example: children or pets, or solid objects, e.g. a wall.
- This chair is not suitable for use by children. Any children in the vicinity must be supervised at all times.
- Take care when adjusting positions to avoid trapping or pinching of body parts, especially in the following areas: under the chair, under or in the leg rest mechanism, between the backrest and seat cushion and under the sides of the chair.
- Do not sit on footrest.
- Only the occupant or a responsible person should operate the chair.
- Exercise care when lowering into the chair as shock loads can severely damage the chair and the mechanism.

**WARNING:**

- Accora shall not be held liable for any damage, injuries or accidents arising from negligence or use that is at variance with this manual.
- Follow the safety features and instructions for operating this product.
- Do not modify this product without the authorisation of the manufacturer.
- Do not use this product if faults have been detected on it that may injure the user, staff or a third person or damage the product or the surroundings.
- Before using this product ensure the user is familiar with its functionality.
- When repairing this product, use only original materials and components otherwise the manufacturer cannot guarantee against any damage that might occur.
- Only use authorised accessories with the chair.
- Only trained service personnel should perform maintenance on the chair.
- Carry out an assessment before seating a user on the chair.
- Do not allow children to play on or with the chair.
- Be aware of any potential fire hazards.
- The chair is intended for indoor use only.
- Do not move the chair if the power cable is connected to the wall.
- Do not route any cable under the chair or through any moving part of the chair. There is a risk of the cable being damaged which could cause an electric shock.

- Do not cover the power supply transformer as it may get warm during use.
- Make sure the transformer and power cables are positioned to avoid causing a trip hazard or other hazard when using the chair.
- Avoid spillage of liquids and water on the electrical system.
- Fully check the chair for functionality if the electrical system becomes wet.
- There is a risk of entrapment while cleaning the chair.
- Do not smoke when using or sitting in the chair.
- Do not fall or drop into the chair as this could severely damage the chair.
- Do not use the chair without the seat cushion.
- Do not use the chair with an electric blanket.
- Do not move the chair when a user is sitting in the chair.
- With all chair rise functions, there is an element of risk and it is recommended to only use the rise function of the chair to a safe height for the user.
- When raising the chair to full height in Flat and Medium Rise, it is possible that the user's feet may be lifted from the floor. This must be taken into consideration when assessing the suitability of the different Rise Position Angle.
- Always adjust the backrest to the fully upright position before raising the chair.
- There is a possibility that materials which the user comes into contact with may cause an allergic reaction.

Page intentionally left blank

These Instructions apply to the Accora Configura® Comfort 1, Lite 2 and Mediatric Chairs. Instructions and illustrations will apply to Comfort 1; any variations for Lite 2 will be noted.

The following features are fitted to Comfort 1 and Mediatric, these are not available on Lite 2:

- Floor castors
- Reversible armrests
- Hoist accessible frame
- Adjustable rise settings
- Adjustable backrest

Before operating this chair, you must read and understand the instructions in this manual. The instructions are mandatory for the safe and effective use of the chair and the safety of the users and carers.

Any actions that are inconsistent with the manual are performed at your own risk and Accora shall not be held liable for any injury or damage.

Please ensure that the manual is available to operators throughout the life of the chair.

It is recommended that the chair configuration is selected by a healthcare professional. The Configura® Comfort 1 and Mediatric Chair Assessment form can be used to help make an assessment. There is no assessment form for Lite 2.

The chair should be regularly checked by the carer / user to ensure the setup is correct and it is working as intended for the user.

Should you have any questions regarding the use of the product do not hesitate to contact Accora customer service on 01223 206100.



Caution, read the instructions before use



For indoor use only

03 Product Description

PRODUCT DESCRIPTION

The Configura® Comfort 1, Lite 2 and Mediatric Chairs are configurable chairs designed to provide comfortable seating to users with mild to moderate postural requirements and to help reduce the formation of pressure ulcers. The functions of the chair will help transfer a user in and out of the chair. The Comfort 1 and Mediatric chair is available in Duratek and Vinyl fabrics. The Lite 2 chair is available in Duratek fabric only. The illustration below shows some key features which will be referred to throughout this manual:

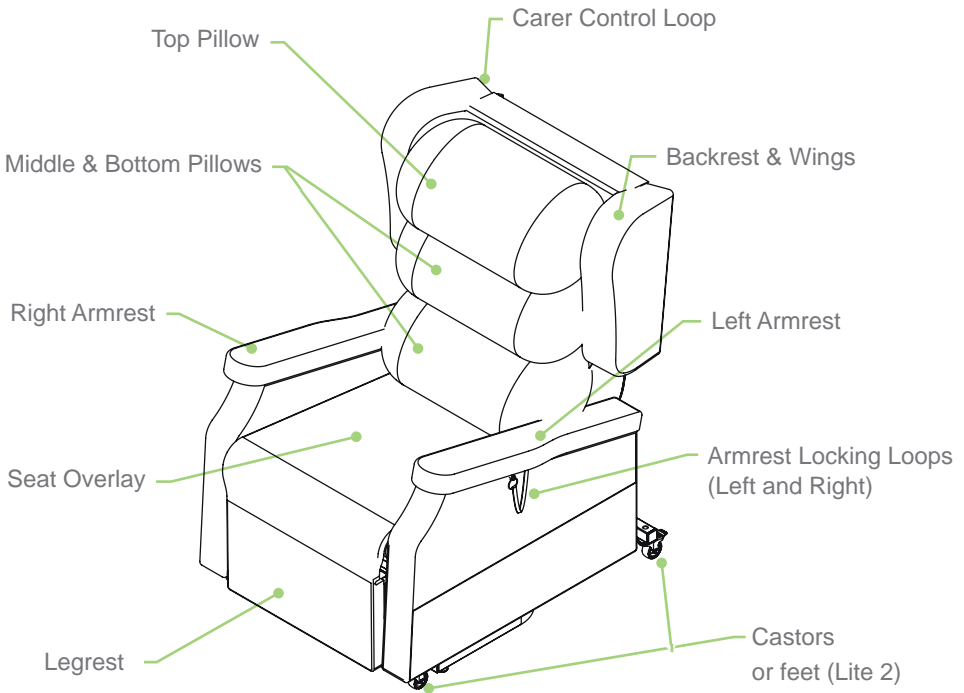

Figure 1 - Configura Comfort 1 Chair

The left and right armrests can be reversed to improve user comfort, see Reversing the Armrests on Page 24 for further information. (Comfort 1 and Mediatric)

The middle and bottom pillows can be repositioned to improve user comfort and support; see Fitting / Adjusting Backrest Pillows on Page 25 for further details.

The castors can be used to move the chair when in the standard seating position. The castors can be locked in position to stop the chair moving when in use. Note: The Lite 2 has four feet instead of castors.

The Seat Overlay comprises a standard seat foam cushion and a legrest cushion enclosed in a durable, 4-way stretch, vapour permeable cover. The seat cushion has a foam insert which can be replaced by any equivalent sized foam insert or air cushion.

The Hand Control can be used to change the position of the backrest (Comfort 1 and Mediatric), legrest, tilt in space angle and can also be used to raise the chair to assist the user in standing or sitting. The hand control loops and carer control loops can be used to store the hand control when not in use.

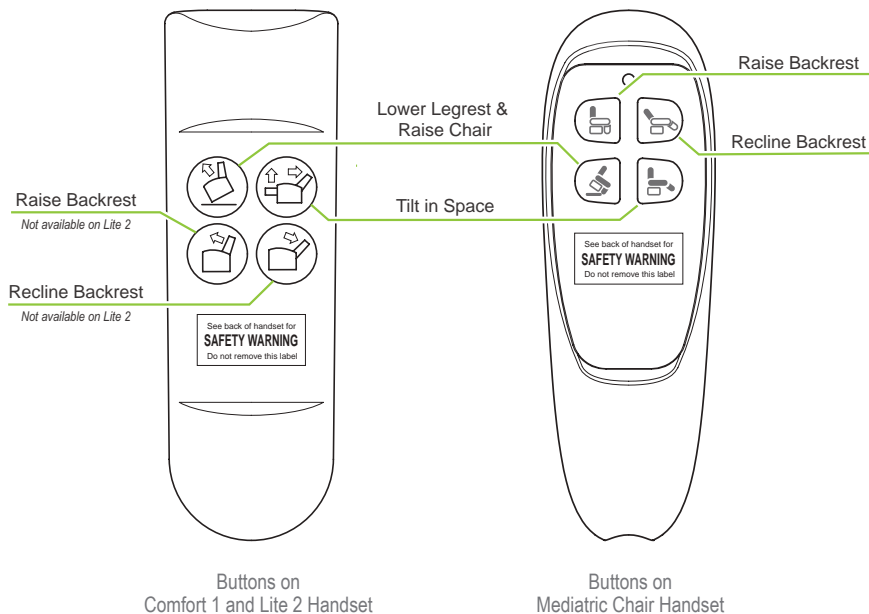

Figure 2 - Handset

Intended Use

The Configura® Comfort 1, Lite 2 and Mediatric Chairs are suitable for use in the following areas:

- Long term medical care where medical supervision is required and monitoring is provided if necessary, e.g. nursing homes and geriatric facilities.
- A domestic area, i.e. home healthcare.

Indications (Appropriate for):

- Comfort 1 and Lite 2: Users up to a maximum weight of 160 kg (352lbs, 25 Stone).
- Mediatric: Users up to a maximum weight of 225kg (496lbs, 35 Stone)

Note: For Comfort 1, the maximum user weight of 160 kg is for chairs in the standard rise setting. For the maximum user weight of chairs in the medium and flat rise positions, refer to Adjustment of the Rise Position Angle on Page 26.

- Users at risk of pressure damage.
- Users with current pressure damage (subject to professional assessment).
- Ambulant, semi-ambulant and non-ambulant users.
- Accommodation and encouragement of good posture.
- Users with neurological conditions.
- Users with a kyphosis.

Contra-Indications (Not appropriate for):

- Demanding postural requirements.
- Users with fixtures and contractures.
- Users with limited extension at the knees.
- Users who need to be transported from room to room.
- Bariatric users.

Posture

The stuffing in the waterfall backrest as well as the position of the cushions can be adjusted to provide support in various ways. In addition, there are alternative options such as wedges, the Lateral Support Backrest and the Adjustable Lateral Support Backrest which can be used to accommodate, encourage or manage posture. The chosen support option should be subject to an assessment carried out by an appropriate healthcare professional.

Pressure

Although the chair is supplied as standard with a foam cushion that provides medium pressure relief, it is also possible to insert alternative pressure cushions such as air cushions or gel cushions. The chosen cushion should be subject to a risk assessment carried out by an appropriate healthcare professional.

Size

The suitability and effectiveness of these features are dependent on correct chair set-up, which is mainly determined by three key elements.

- Seat depth.
- Seat to floor height.
- Seat width.

The Configura® Comfort 1, Lite 2 and Mediatric Chair should be regularly checked to ensure the set-up is correct and that it is working as intended for the user.

05 Before Use

BEFORE USE



WARNING:

- Carry out an assessment before seating a user with specific postural requirements, a user with pressure injury or at risk of developing pressure injury, or a user with behavioural conditions (e.g. Huntington's disease).
- Do not leave a semi-ambulant user unattended in the chair if it puts the user at risk.
- Never use the chair without appropriate cushion and pillows in the correct position.
- Check the chair for adjustment for each new user.
- Check the chair for functionality before the first use and at regular intervals during use.
- Do not use the product if the sides of the chair become loose.
- Do not route any cable under the chair or through any moving part of the chair. There is a risk of the cable being damaged which could cause an electric shock.
- Do not plug the power cable into an extension lead. Always plug directly into a mains socket.
- Make sure the transformer and power cables are positioned to avoid causing a trip hazard or other hazard when using the chair.
- Do not position the chair on an uneven surface.
- Do not smoke when using or sitting in the chair.
- Only trained carers and cognitive users should operate the chair.
- Do not operate the hand controller for more than 2 minutes continuously in any 20 minute period. Long periods of continuous use will damage the chair.

WARNING:

For Comfort 1 and Mediatric Chair, always apply the castor brakes before seating a user in the chair. **Note: The Lite 2 has four feet instead of castors.**

Before use, always do the following:

1. Position the chair on a flat surface free from any obstruction. Always allow sufficient space behind and in front of the chair to allow the chair to be fully reclined (See figure 4). Do not allow the chair to touch the wall or other furniture when in use.

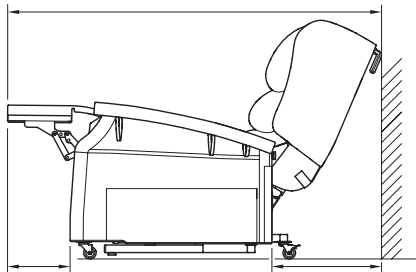

See Section 16 Technical Specification for the measurements for each chair size

Figure 4 - Chair to wall / furniture measurement

2. Apply the castor brakes (Comfort 1 and Mediatric) (See Page 18).
3. If the Battery Operated Reset System is to be used, install the batteries (see Battery Operated Reset System on page 28).
4. Plug the power cable into a power socket and switch the socket on.
5. **Make sure the transformer and power cables are positioned to avoid causing a trip hazard or other hazard when using the chair.**
6. Adjust the chair to an upright position (See Hand Controls and Changing Chair Positions) on Pages 20 and 21 respectively.
7. Check that the backrest fully reclines and returns to the upright position without being obstructed.
8. Tilt the chair to its maximum and return to the riser position.
9. Adjust the chair again to the upright position.

The chair is ready for use if all the movements are smooth and no problems are detected.

Using the Castor Brakes (Comfort 1 and Mediatric)

WARNING:

- **Always wear sturdy shoes when using the brakes**

The chair has two brakes, one located on each rear castor. The brakes must be applied on both rear castors when the chair is ready to be used. The brakes can be activated by pressing on the brake with a foot.

Note: The diagram below shows the left castor brake

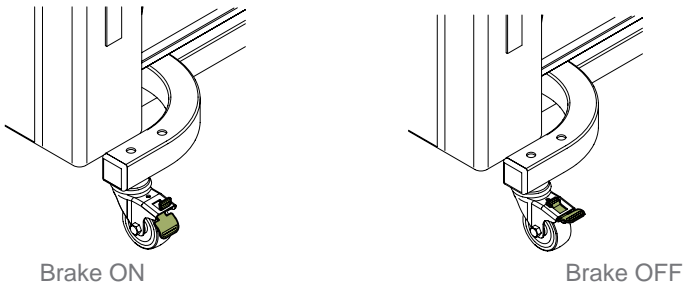

Figure 5 - Castor Brakes

To apply the brake on each castor, push down on the castor brake until it is in the ON position (See Fig 5).

To release the brake, push down on the top of the castor brake until the brake is in the OFF position (See Fig 5).

Chair Positions

The Configura® Comfort 1, Lite 2 and Mediatric Chairs can be set to the following positions:



Upright Position



Tilt in Space (TIS) Position



Raise Chair Position



Backrest UP Position
(Comfort 1 and Mediatric)











Backrest DOWN Position
(Comfort 1 and Mediatric)

Hand Controls

The chair is controlled by four buttons (two buttons on Lite 2) on the front of the hand control.

Always store the hand control in the pocket on the side of the chair or on the loops provided. This will ensure it does not suffer accidental damage.

Button	Function	Description
 	Raise Chair (Standing / Sitting Assist)	<ol style="list-style-type: none"> 1. The chair will move from the upright position to the rise position by pressing this button. 2. The chair will move from Tilt In Space (TIS) position to the upright position by pressing this button.
 	Tilt in Space (TIS)	<ol style="list-style-type: none"> 1. The chair will move from the upright position to TIS position by pressing this button. 2. The chair will move from the rise position to the upright position by pressing this button.
 	Backrest UP	The backrest will return to the upright position by pressing this button. (Comfort 1 and Mediatric)
 	Backrest DOWN	The backrest will recline by pressing this button. (Comfort 1 and Mediatric)



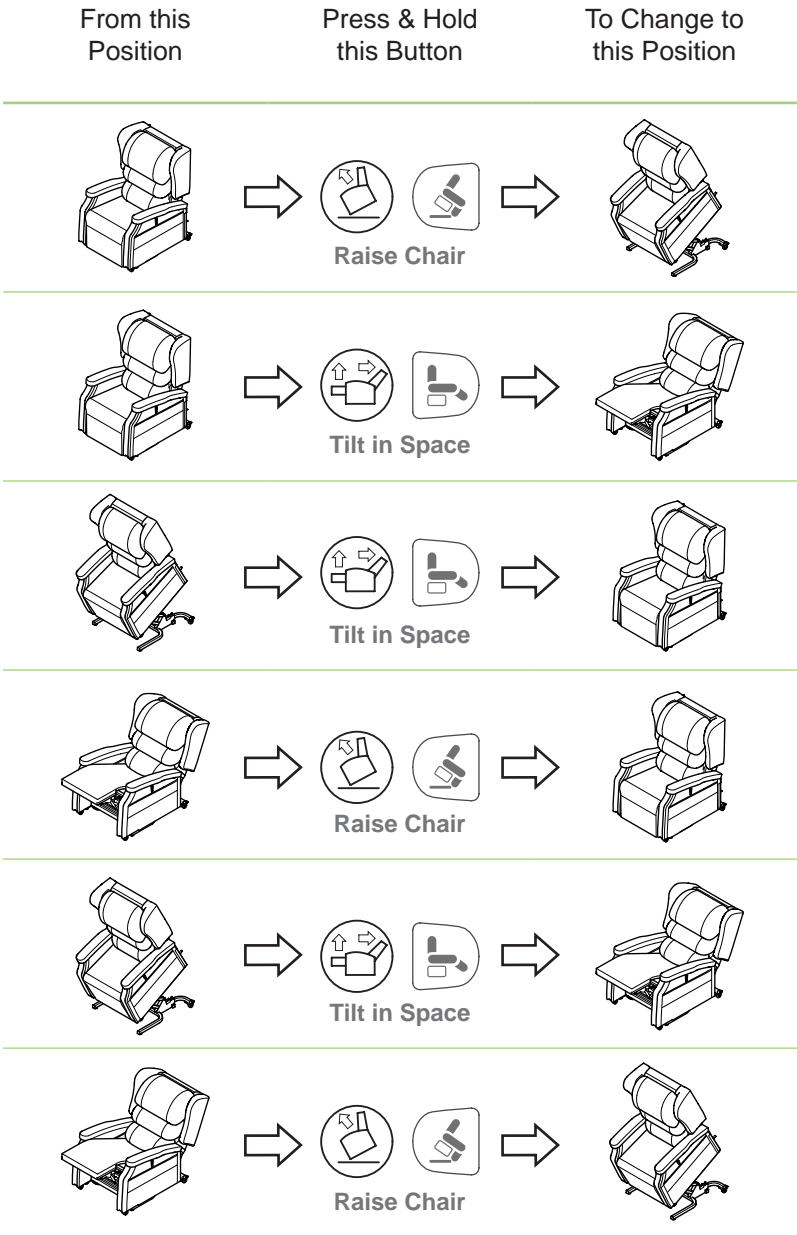

Changing Chair Positions

The following is a guide to changing the chair positions:



Adjusting the Angle of the Backrest (Comfort 1 and Mediatric)

The angle of the backrest can be adjusted when the chair is in any position. To adjust the backrest angle:

Button	Function	Description
 	Raise Backrest	Press and hold the bottom left button to raise the backrest to the upright position. (Comfort 1 and Mediatric)
 	Recline Backrest	Press and hold the bottom right button to recline the backrest to the fully reclined position. (Comfort 1 and Mediatric)

Locking out the Hand Control

There may be situations when the hand control needs to be locked out so that pushing the buttons does not operate the chair. This may be necessary, for instance, if there are children who might fiddle with the hand control; this risk should be assessed by the Prescriber when prescribing the chair.

The hand control lockout is located at the rear of the chair, at the rear of one of the side pieces.

To disconnect, flip up the locking catch and pull apart the plug and socket.

Ensure the loose plug and socket are attached to the chair using the Velcro strap.

To connect, push the plug and socket together, and close the locking catch until it clicks.

Ensure the cable is securely attached to the chair using the Velcro strap.

Check that all functions of the chair operate correctly.

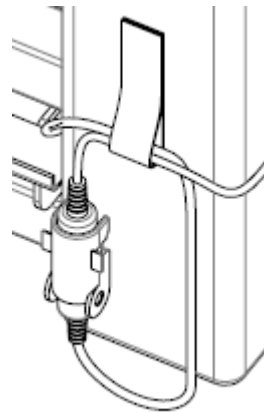

Figure 6 - Hand Control Lockout

The following adjustments are available for the chair. Please contact your Prescriber or Service personnel for more information.

Backrest Position / Seat Depth Adjustment

The backrest depth can be adjusted to help make a user more comfortable and provide better support. The standard backrest depth can be adjusted to be either 457 mm (18") or 508 mm (20").

There is also an additional Depth Adjustment Kit available to decrease the depth of the seat by a further 51 mm (2") from 457mm (18") to a minimum of 406 mm (16").

Please Note: The backrest position and further Depth Adjustment Kit must be adjusted / fitted by trained personnel only. Please contact your Prescriber or Service personnel.

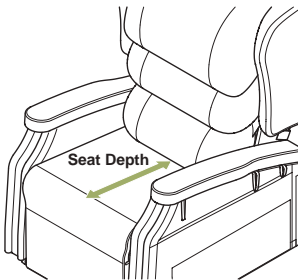

Standard =
457 mm (18") or 508 mm (20")

With Backrest Depth Adjustment Kit =
Minimum 406mm (16")

Figure 7 - Seat Depth Dimensions

Chair Height Adjustment

Using a Height Adjustment Kit, the chair height can be increased by 1" (25mm) or 2" (50mm) to make a user more comfortable. The 1" (25mm) height adjustment kit is only available for Comfort 1 and Mediatric Chair.

Notes:

- The chair height adjustment kit must be fitted by trained personnel only. Please contact your Prescriber or Service personnel.
- When the height adjustment kit has been fitted, the castors are lifted away from the floor and cannot be used to move the chair. (This does not apply to Lite 2 as castors are not fitted)

Using other Mobility Aids with the Chair

The Configura® Comfort 1 and Mediatric Chair has been designed to enable other mobility aids, such as transfer aids or hoists to be used with the chair. When using any other product with the chair a full risk assessment must be carried out and the instructions for use of the equipment must be adhered to.

If a transfer aid is being used which requires access below the chair, the chair must be raised sufficiently to permit the legs of the transfer aid to be slid under the chair.

Sliding the Armrests (Comfort 1 and Mediatric)

The comfort 1 and Mediatric chair armrest may be moved back to accommodate transfer aids, e.g. Sara Steady or equivalent. To move the arm, pull the locking pin using the loop and slide the arm backwards. Once the transfer is complete, slide the arm forward and ensure it locks firmly in the forward position.

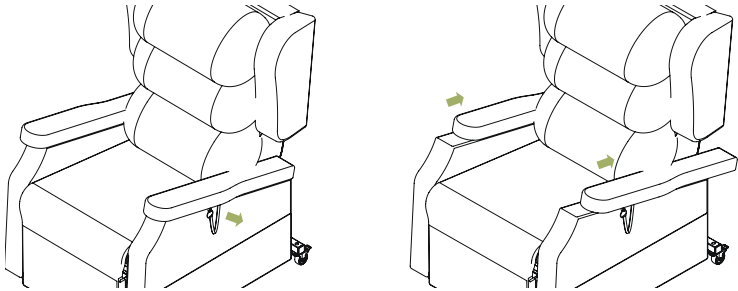

Figure 8 - Sliding Armrest

Reversing the Armrests (Comfort 1 and Mediatric)

The armrests can be reversed. The right armrest can be fixed on the left side of the chair and the left armrest can be fixed on the right side of the chair. This procedure reduces the inside distance between the armrests by approximately 40 mm (1.5”).

To reverse the armrests, pull the locking pin using the loop and slide the armrest back then pull forwards trying to lift the armrest, take the armrest out to put the other side armrest in. Slide the armrest forward and ensure it locks firmly in the forward position.

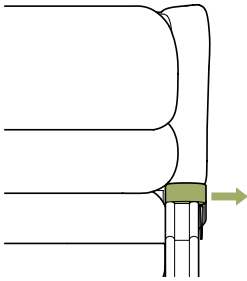

Figure 9 - Standard Position

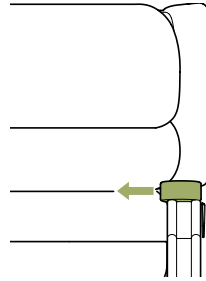

Figure 10 - Reversed Position

Please Note:

Reversing the armrests must be carried out by trained personnel only.
Please ask your Prescriber or Service personnel.

Seat Overlay Options

WARNING:

- **Make sure a replacement insert foam is the correct size to fit the overlay and has the correct support properties to give the user the correct support and pressure care.**

The seat overlay is supplied as standard with an integrated Visco insert foam. The insert foam can be replaced by an equivalent insert foam which is 457 mm x 457 mm x 76 mm (18" x 18" x 3").

Please Note:

A replacement seat cushion insert foam must be fitted by trained personnel only. Please contact your Prescriber or Service personnel.

Fitting / Adjusting Backrest Pillows

There are three backrest pillows fitted to the chair using the hook and loop fasteners on the backrest. The middle and bottom pillows are the same size and can be interchanged. The top pillow is a different size and must always be used in the top position.

The middle and lower pillows can be re-arranged depending on the needs of the user. The pillows can be positioned vertically instead of horizontally as shown below:

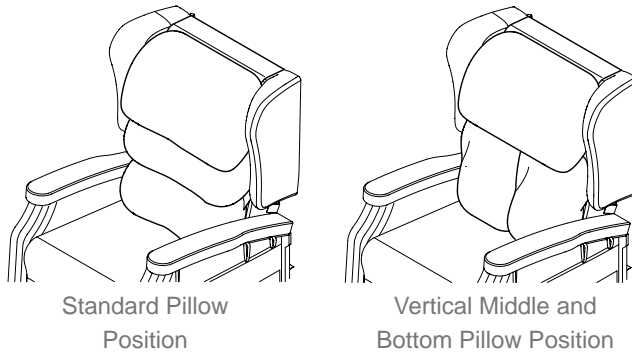

Figure 11 - Fitting / Adjusting Backrest Pillows

Pillow Filling Adjustment

The pillow filling quantity can be adjusted to improve user comfort. If a pillow needs to be adjusted, please contact your Prescriber or Service personnel.

Adjustment of the Rise Position Angle (Comfort 1 only)

The standard Rise Position Angle of the chair is 23°. This angle can be adjusted to a Medium Rise position which has an angle of 14° and a Flat Rise position which has an angle of only 2° (See Figure 11 on next page). Flat Rise is often used with a standing aid as it allows the chair to be raised to gain access for the standing aid without the user being tipped forward.

With all chair rise functions, there is an element or risk and it is recommended to only use the rise function of the chair to a safe height for the user.

When raising the chair to full height in Flat and Medium Rise, it is possible that the user's feet may be lifted from the floor. This must be taken into consideration when assessing the suitability of the different Rise Position Angle.

The chair Rise Position Angle can only be adjusted by trained personnel. Please contact your Prescriber or Service personnel.

Changing the Rise Position Angle of the chair will affect the maximum user weight for that chair. The maximum user weights will be affected as follows:

Chair Sizes	Maximum User Weight (kg)		
	Standard Rise (23°)	Medium Rise (14°)	Flat Rise (2°)
Extra Small & Small Low Profile (Medium & Large)	160 kg	110 kg	80 kg
Small Tall Medium & Large	160 kg	135 kg	110 kg
Mediatric Chair 24" & 26" Seat Width	225kg	TBC	TBC

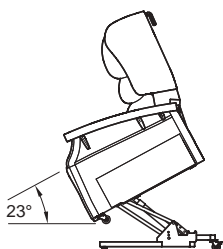

Standard Rise (23°)

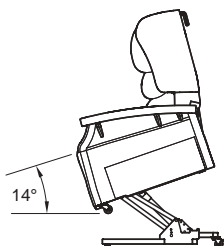

Medium Rise (14°)



Flat Rise (2°)

Figure 12 - Rise Position Angles

Hand Control Location Options

The hand control may be mounted in any of the following positions:

- User position - left side of chair
- User position - right side of chair
- Care position - top of backrest

Changing the location of the Hand Control must only be carried out by trained personnel. Please contact your Prescriber or Service personnel.

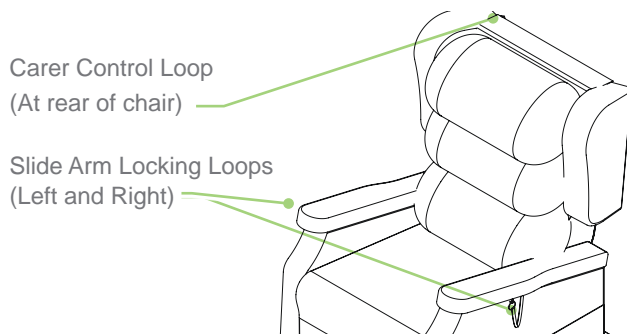

Figure 13 - Hand Control Location Options

09 Using Battery System

Accora supplies two type of battery systems for the Configura® Comfort 1 and Lite 2 Chair. This includes a Battery Operated Reset System, or Li-ion battery for general use when there is a power outage.

To Use Battery Operated Reset System:

This system is for emergency use only and will enable the operator to return the chair to the normal upright position in the event of a mains power failure. This system is not designed for general use.



Warnings:

- **The battery system will only return the chair to the upright position. It will not raise the chair.**
- **Only use Alkaline 9V batteries. Other types of 9V battery may not operate the reset system. Accora recommends that the batteries are replaced every 12 months.**

To use the Battery Operated Reset System, two 9V Alkaline batteries must be installed into the battery compartment of the Transformer. Ensure the mains cable is unplugged before the batteries installation or replacement.

1. Unplug the mains cable from the power socket.
2. Turn the transformer over and slide the battery lid open.
3. Install 2 x 9V Alkaline batteries into the transformer.
4. Slide the battery lid closed.
5. Turn the transformer back over so that the DC power light faces upwards.
6. Plug the mains cable back into the socket and switch the socket on.

To Use Li-ion Battery for General Use:

Accora supplies rechargeable Li-ion battery pack for general use as an optional kit. We recommend that the battery is charged weekly. If the chair functions are used a lot, then it should be charged daily.

If you have Li-ion on hand, slide it to the transformer slot firmly. A light click sound indicates the battery is fitted properly. Turn the transformer over so that the power light faces upwards. Ensure the battery and transformer is located on the floor properly. Cables should not be stretched, no other objects put on the transformer.

The Configura® Comfort 1, Lite 2 and Mediatric Chairs have the following accessories available. Please contact your Prescriber or Service personnel for more information.

Depth Adjustment Kit

The Depth Adjustment Kit is an accessory designed to decrease the depth of the chair by 2" (51 mm). The chair Depth Adjustment Kit must only be fitted by trained personnel. Please contact your Prescriber or Service personnel.

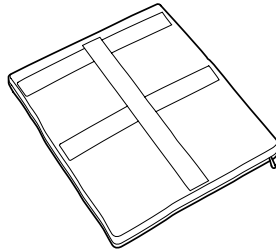

Figure 14 - Depth Adjustment Kit

Height Adjustment Kit

The Height Adjustment Kit is an accessory designed to increase the height of the chair. The Comfort 1 and Mediatric Chair have height adjustment kits for 1"(25mm) and 2" (50mm). The Lite 2 has a height adjustment kit for 2"(50mm) only. The chair Height Adjustment Kit must only be fitted by trained personnel. Please contact your Prescriber or Service personnel.

Note: When the Height Adjustment Kit is fitted to Comfort 1 or Mediatric, the castors are lifted away from the floor and cannot be used to move the chair.

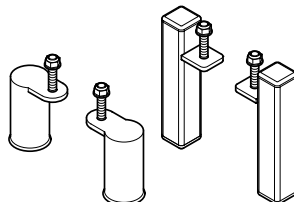

Figure 15 - Height Adjustment Kit 2" (50mm)

Lateral Supports

The Lateral Supports are an accessory to be used underneath the standard backrest pillows and provide a moderate postural support for the user. The Lateral Supports must only be fitted by the Prescriber or Service personnel.

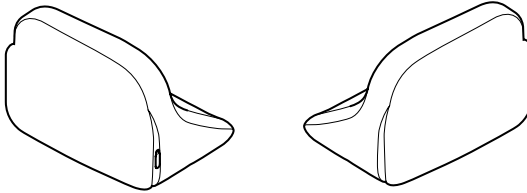

Figure 16 - Lateral Supports

Lateral Support Backrest

The Lateral Support Backrest is an accessory designed to replace the middle and bottom pillows and encourages a good midline sitting position for users who need extra support. Figure 16 shows this fitted to a chair and used together with the Profiled Headrest. The Lateral Support Backrest must only be fitted by the Prescriber or Service personnel.

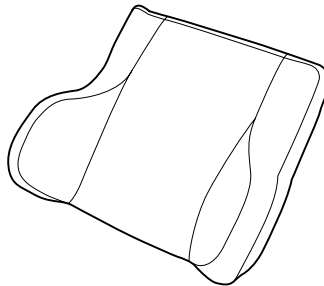

Figure 17 - Lateral Support Backrest

Adjustable Lateral Support Backrest

The Adjustable Lateral Support Backrest is an accessory designed to replace the middle and bottom pillows and gives more lateral support together with mild positioning and correction capabilities. Figure 16 shows this fitted to a chair and used together with the Profiled Headrest. The Adjustable Lateral Support Backrest must only be fitted by the Prescriber or Service personnel.

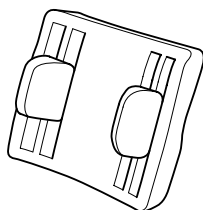

Figure 18 - Adjustable Lateral Support Backrest

Profiled Headrest

The Profiled Headrest is an accessory which can replace the standard top pillow. It can also be fitted when using the Lateral Support Backrest or the Adjustable Lateral Support Backrest. The Profiled Headrest must only be fitted by the Prescriber or Service personnel.

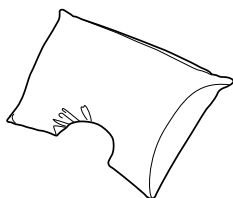
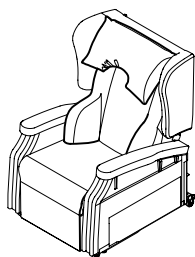
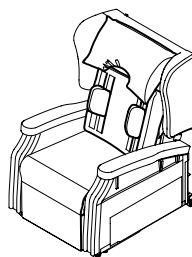

Figure 19 - Profiled Headrest



Used with Lateral
Support Backrest



Used with Adjustable
Lateral Support Backrest

Figure 20 - Profiled Headrest Examples

Channel Legrest

The Channel Legrest is an accessory to be fitted to the top of the standard legrest. The Channel Legrest provides side support for the user to reduce sideways movement of the legs.

The Channel Legrest must only be fitted by the Prescriber or Service personnel.

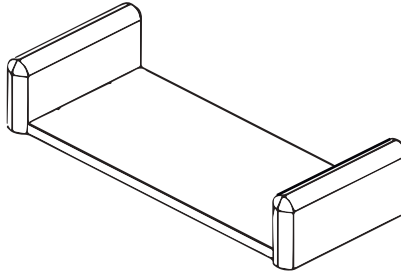

Figure 21 - Channel Legrest

Two Button Hand Control

The Two Button Hand Control is fitted as standard to the Lite 2. It is available as an accessory to be fitted to the Comfort 1 in place of the standard Four Button Hand Control.

The Two Button Hand Control does not control the backrest and is used if the user needs to be prevented from adjusting the backrest position.

The Two Button Hand Control must only be fitted by the Prescriber or Service personnel.

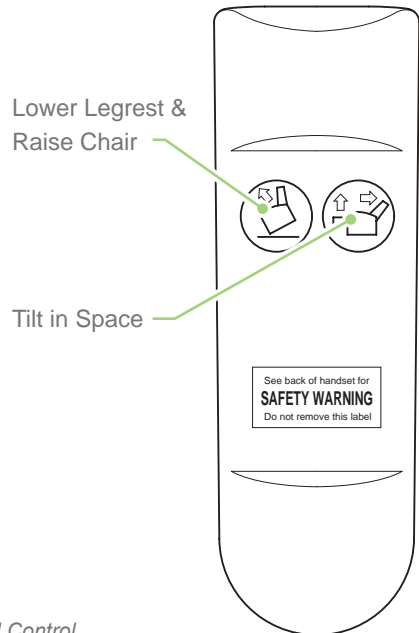

Figure 22 - Two Button Hand Control



WARNING:

- **Do not use the chair if it shows signs of incorrect performance. Contact Accora Customer Service.**
- **Do not use the chair if the user or carer is aware that any parts of the chair are corroded. Contact Accora Customer Service.**
- **Do not use the chair if the upholstery shows any signs of damage or excessive wear. Contact Accora Customer Service.**
- **If you notice the user is not comfortable with the product, take it out of service. Contact Accora Customer Service.**
- **Maintenance on the chair must only be performed by competent persons.**

General Maintenance

We recommend the chair is checked on a weekly basis.

Place the chair on a flat surface and apply the castor brakes (not on Lite 2). Plug in the power cable and adjust the chair to an upright position. Check that the backrest fully reclines and returns to the upright position (not on Lite 2). Tilt the chair to its maximum, and return to the riser position. Adjust the chair again to the upright position. The chair is ready for use if all the movements are smooth and no abnormalities are detected.

Check that the power cables and the handset cable are in good condition.

Check castors (Comfort 1 and Mediatric) regularly for build-up of fluff and dirt particles.

Should you have any question regarding the maintenance of the product do not hesitate to contact Accora Customer Service.

Daily Maintenance

Before each use, check the chair for signs of damage, excessive wear or incorrect performance.

Clean and care for the fabric on a regular basis and it will maintain its condition and appearance.



WARNING:

- **A chair can be a source of infection and we recommend that you clean it regularly.**
- **Before cleaning the chair unplug the mains cable from the socket.**
- **Avoid spillage of liquids while cleaning the product.**
- **Fully check the functionality of the chair after it has been cleaned.**

Cleaning Instructions

When cleaning the chair, use protective clothing such as gloves and aprons. Infection could be transmitted from user to user if the chair is reused, or from user to carer or cleaner.

After the chair has been cleaned, fully check for functionality. Place the chair on a flat surface and apply the castor brakes (Comfort 1 and Mediatric Chair). Plug in the mains cable and adjust the chair to an upright position. Check that the backrest fully reclines and returns to the upright position (Comfort 1 and Mediatric Chair). Tilt the chair to its maximum, and return to the riser position. Adjust the chair again to the upright position. The chair is ready for use if all the movements are smooth and no abnormalities are detected.

Metal Frame

Remove the dust with a dry cloth. For deeper cleaning, use a damp cloth with, if necessary, a soapy water solution and wipe clean. Avoid spillage of liquids on the electrical system of the chair.

Disinfection

For extreme soiling control only, use a 5% Sodium Hypochlorite (Bleach) solution. Do not use solvents or acid based cleaners.

Fabric and Covers

Clean and care for the fabric or vinyl upholstery on a regular basis and it will maintain its condition and appearance.

The new generation of Microfibre cleaning cloths without soap are extremely effective for general care and maintenance. You can also wipe clean regularly with a damp cloth to remove dust particles and light soiling. It is recommended to vacuum the upholstery once a week.

Most stains can be removed by wiping clean. Remove spillages promptly (within 15 minutes) with cold water. For extreme soiling control use a 5% Sodium Hypochlorite (Bleach) solution.

Do not machine wash or dry clean.

Do not apply other chemicals such as acid based cleaners, polish, solvents or stain remover.

Storage

Do not store or use the chair in damp or wet areas. Do not position the chair near or against sources of direct heat or naked flames. Cover materials may fade or degrade if subjected to excessive heat or sunlight.

Transporting the chair

The backrest, side pieces and overlay cushion can be easily removed without tools. For details on how to dismantle the chair consult the Service Manual.

Disassembly Information

The chair can be disassembled (e.g. for transportation). The chair must be disassembled / assembled only by trained service personnel.

14 Product Disposal

Disposal of this product should be in accordance with local regulations.

The steel frame and the cardboard packaging can be recycled. The actuators, transformer, handset and cables are electrical equipment and should be collected separately and disposed of in an environmentally correct manner. The upholstery parts cannot practicably be recycled.

 **WARNING:**

- If you notice that the chair is not operating correctly contact Accora Customer Service on 01223 206100.
- Only use the transformer supplied with the chair or a replacement supplied by Accora.
- Always disconnect the chair from the power supply before checking any part of the chair.
- Do not use the product if any of the power cables are damaged.
- Do not move the chair whilst a person is sitting in it.

The following table gives possible problems that may occur when using the Configura® Comfort 1, Lite 2 and Mediatric Chair and possible solutions to the problem.

After troubleshooting, if the chair shows signs of incorrect performance do not use the product and contact Accora Customer Service:

Symptom	Possible Cause(s)	Action(s)
Chair does not function when using the hand control	Chair power cord not plugged into mains socket	Plug the chair power cord into a mains socket and switch on
	Power socket plugged in but socket not switched on	Switch the power socket on
	Power cable and / or chair cable not plugged in to the transformer	Plug the power cable and the chair cable into the transformer
	Power socket not functional	Check another appliance using the power socket
	Hand Control not plugged in	Contact Accora Customer Service

Symptom	Possible Cause(s)	Action(s)
Chair does not fully recline	Chair too close to wall or furniture	Move chair away from any wall or furniture which is impeding the chair movement. Check for any damage to the chair, wall and / or furniture
Chair does not fully go down to the upright position	Chair may be too close to wall or furniture	Move the chair away from any wall or furniture which is impeding the chair movement
		Check no objects are under the chair stopping the movement
The user is uncomfortable in the chair	Chair position not suitable for user	Change chair to a comfortable position
	Pillows not adjusted for comfort	Adjust pillows to make the user comfortable
	Configuration of chair incorrect for user	Contact Prescriber to discuss size and accessory options

Model Numbers

Comfort 1 Duratek

Model Number	Description
CHAIR-0-CM1-040	Configura Comfort 1 Chair - Extra Small
CHAIR-0-CM1-140	Configura Comfort 1 Chair - Small
CHAIR-0-CM1-240	Configura Comfort 1 Chair - Medium
CHAIR-0-CM1-340	Configura Comfort 1 Chair - Large
CHAIR-T-CM1-140	Configura Comfort 1 Chair - Small Tall
CHAIR-LP-CM1-240	Configura Comfort 1 Chair - Medium Low Profile
CHAIR-LP-CM1-340	Configura Comfort 1 Chair - Large Low Profile

Comfort 1 Vinyl

Model Number	Description
CHAIR-0-CM1-030VN	Configura Comfort 1 Chair - Extra Small
CHAIR-0-CM1-130VN	Configura Comfort 1 Chair - Small
CHAIR-0-CM1-230VN	Configura Comfort 1 Chair - Medium
CHAIR-0-CM1-330VN	Configura Comfort 1 Chair - Large
CHAIR-T-CM1-130VN	Configura Comfort 1 Chair - Small Tall
CHAIR-LP-CM1-230VN	Configura Comfort 1 Chair - Medium Low Profile
CHAIR-LP-CM1-330VN	Configura Comfort 1 Chair - Large Low Profile

Lite 2 Duratek

Model Number	Description
CHAIR-0-CM2-140	Configura Lite 2 Chair - Small
CHAIR-0-CM2-240	Configura Lite 2 Chair - Medium
CHAIR-0-CM2-340	Configura Lite 2 Chair - Large

Mediatric Chair Duratek

Model Number	Description
CHAIR-0-CM4-440	Comfort Mediatric Chair, Seat Width 600mm (24")
CHAIR-0-CM4-540	Comfort Mediatric Chair, Seat Width 650mm (26")

Mediatric Chair Vinyl

Model Number	Description
CHAIR-0-CM4-430VN	Comfort Mediatric Chair, Seat Width 600mm (24")
CHAIR-0-CM4-530VN	Comfort Mediatric Chair, Seat Width 650mm (26")

Configura® Comfort 1 and Lite 2 Chair

Noise Level:	< 60dB
User Weight Limit See Page 26	160 kg (352 lbs, 25 Stones) Rise Position Angle will affect Weight Limit
Expected Service Life:	7 Years

Power Supply, Comfort 1 and Lite 2

Accora Part No.:	TNSFM-0-CM1-100
Power Mains Input:	AC100-240 V 50 / 60 Hz 1.5 A
Power Output:	DC 29 V 1.8 A
Fuse Rating:	5A
Degree of protection against electric shock:	Class II Double Insulated
Degree of protection against liquid ingress:	IP20

Backrest Actuator (Comfort 1 only)

Accora Part No.:	ACTBR-0-CM1-100
Power Input:	DC 24 V 4A
Degree of protection against liquid ingress:	IP20
Duty Cycle:	2 min ON / 18 min OFF

Lift Actuator, Comfort 1 and Lite 2

Accora Part No.:	ACTMN-0-CM1-100
Power Input:	DC 24 V 2.2A
Degree of protection against liquid ingress:	IP20
Duty Cycle:	0.5 min ON / 4 min OFF

Comfort Mediatric Chair

Noise Level:	< 60dB
User Weight Limit	225 kg (496 lbs, 35 Stones)
Expected Service Life:	7 Years

Power Supply, Comfort Mediatric

Accora Part No.:	KITCAB-0-CM4-000
Power Mains Input:	AC220-240 V 50 / 60 Hz 2.5 A
Power Output:	DC 29 V 145VA
Fuse Rating:	10A
Degree of protection against electric shock:	Class II Double Insulated
Degree of protection against liquid ingress:	IP20

Backrest Actuator, Comfort Mediatric

Accora Part No.:	ACTBR-0-CM4-000
Power Input:	DC 24 V 6A
Degree of protection against liquid ingress:	IP20
Duty Cycle:	2 min ON / 18 min OFF

Lift Actuator, Comfort Mediatric

Accora Part No.:	ACTMN-0-CM4-000
Power Input:	DC 24 V 3.6A
Degree of protection against liquid ingress:	IP20
Duty Cycle:	0.5 min ON / 4 min OFF

Dimension (See Fig 22)	Extra Small	Small	Small Tall	Medium Low Profile	Medium	Large Low Profile	Large
Seat height (A)	406 mm (16")	406 mm (16")	457 mm (18")	406 mm (16")	457 mm (18")	406 mm (16")	457 mm (18")
Seat height with 1" HAKs (A)	431 mm (17")	431 mm (17")	482 mm (19")	431 mm (17")	482 mm (19")	431 mm (17")	482 mm (19")
Seat height with 2" HAKs (A)	457 mm (18")	457 mm (18")	508 mm (20")	457 mm (18")	508 mm (20")	457 mm (18")	508 mm (20")
Seat width (B)	406 mm (16")	457 mm (18")	457 mm (18")	508 mm (20")	508 mm (20")	559 mm (22")	559 mm (22")
Seat depth position 1 (C)	457 mm (18")	457 mm (18")	457 mm (18")	457 mm (18")	457 mm (18")	457 mm (18")	457 mm (18")
Seat depth position 2 (C)	508 mm (20")	508 mm (20")	508 mm (20")	508 mm (20")	508 mm (20")	508 mm (20")	508 mm (20")
Armrest height (D)	180 mm (7.1")	180 mm (7.1")	180 mm (7.1")	180 mm (7.1")	180 mm (7.1")	180 mm (7.1")	180 mm (7.1")
Overall Width (E)	700 mm (27.5")	750 mm (29.5")	750 mm (29.5")	800 mm (31.5")	800 mm (31.5")	850 mm (33.5")	850 mm (33.5")
Overall Height – Upright (F)	1080 mm (42.5")	1080 mm (42.5")	1115 mm (43.9")	1080 mm (42.5")	1115 mm (43.9")	1080 mm (42.5")	1115 mm (43.9")
Overall Length – Upright (G)	885 mm (34.8")	885 mm (34.8")	940 mm (37")	925 mm (36.4")	940 mm (37")	925 mm (36.4")	940 mm (37")
Rise height to front of chair (H)	Standard	510 mm (20.1")	545 mm (21.5")	510 mm (20.1")	545 mm (21.5")	510 mm (20.1")	545 mm (21.5")
	Medium	570 mm (22.4")	570 mm (22.4")	620 mm (24.4")	620 mm (24.4")	570 mm (22.4")	620 mm (24.4")
Total Length Fully Reclined (J)	Flat	660 mm (26")	660 mm (26")	710 mm (28")	660 mm (26")	660 mm (26")	710 mm (28")
	Comfort 1	1565 mm (61.6")	1565 mm (61.6")	1660 mm (65.4")	1600 mm (63")	1600 mm (63")	1660 mm (65.4")
Chair to wall / furniture (K)	Lite 2	1400 mm (55.1")	1400 mm (55.1")	N/A	N/A	N/A	1400 mm (55.1")
	Comfort 1	570 mm (22.4")	570 mm (22.4")	605 mm (23.8")	600 mm (25.6")	600 mm (25.6")	605 mm (23.8")
Chair to wall / furniture (K)	Lite 2	350 mm (13.8")	350 mm (13.8")	N/A	N/A	N/A	350 mm

Dimension (See Fig 22)	Mediatic - 24"	Mediatic - 26"
Seat height (A)	400 mm (16")	400 mm (16")
Seat height with 1" HAKs (A)	425 mm (17")	425 mm (17")
Seat height with 2" HAKs (A)	450 mm (18")	450 mm (18")
Seat width (B)	600 mm (24")	650 mm (26")
Seat depth position 1 (C)	450 mm (18")	450 mm (18")
Seat depth position 2 (C)	500 mm (20")	500 mm (20")
Armrest height (D)	180 mm (7.1")	180 mm (7.1")
Overall Width (E)	900 mm (27.5")	950 mm (29.5")
Overall Height – Upright (F)	1080 mm (42.5")	1080 mm (42.5")
Overall Length – Upright (G)	885 mm (34.8")	885 mm (34.8")
Rise height to front of chair (H)	510 mm (20.1")	510 mm (20.1")
Total Length Fully Reclined (J)	1565 mm (61.6")	1565 mm (61.6")
Chair to wall / furniture (K)	570 mm (22.4")	570 mm (22.4")

Chair Weights

Chair Model	Description	Weight
CHAIR-0-CM1-040	Comfort 1 - Extra Small	63 kg (139 lbs)
CHAIR-0-CM1-140	Comfort 1 - Small	
CHAIR-0-CM1-130VN	Comfort 1 - Small	65 kg (143 lbs)
CHAIR-0-CM2-140	Lite 2 - Small	
CHAIR-0-CM1-240	Comfort 1 - Medium	
CHAIR-0-CM1-230VN	Comfort 1 - Medium	68 kg (150 lbs)
CHAIR-0-CM2-240	Lite 2 - Medium	
CHAIR-0-CM1-340	Comfort 1 - Large	
CHAIR-0-CM1-330VN	Comfort 1 - Large	71 kg (156 lbs)
CHAIR-0-CM2-340	Lite 2 - Large	
CHAIR-T-CM1-140	Comfort 1 - Small Tall	67 kg (148 lbs)
CHAIR-LP-CM1-240	Comfort 1 - Medium Low P	66 kg (145 lbs)
CHAIR-LP-CM1-340	Comfort 1 - Large Low P	69 kg (152 lbs)
CHAIR-0-CM4-440	Mediatic Chair - 24"	79kg (174 lbs)
CHAIR-0-CM4-540	Mediatic Chair - 26"	83kg (183 lbs)
CHAIR-0-CM4-430VN	Mediatic Chair - 24"	79kg (174 lbs)
CHAIR-0-CM4-530VN	Mediatic Chair - 26"	83kg (183 lbs)

Seat Angles – Comfort 1

Dimension (See Fig 22)	Angle
Standard seat angle (a°)	6°
Tilt in space seat angle (b°)	26°
Rise angle (standard position) (c°)	23°
Rise angle (medium position) (c°)	14°
Rise angle (flat position) (c°)	2°
Standard backrest angle (d°)	100°
Recline backrest angle (e°)	128°

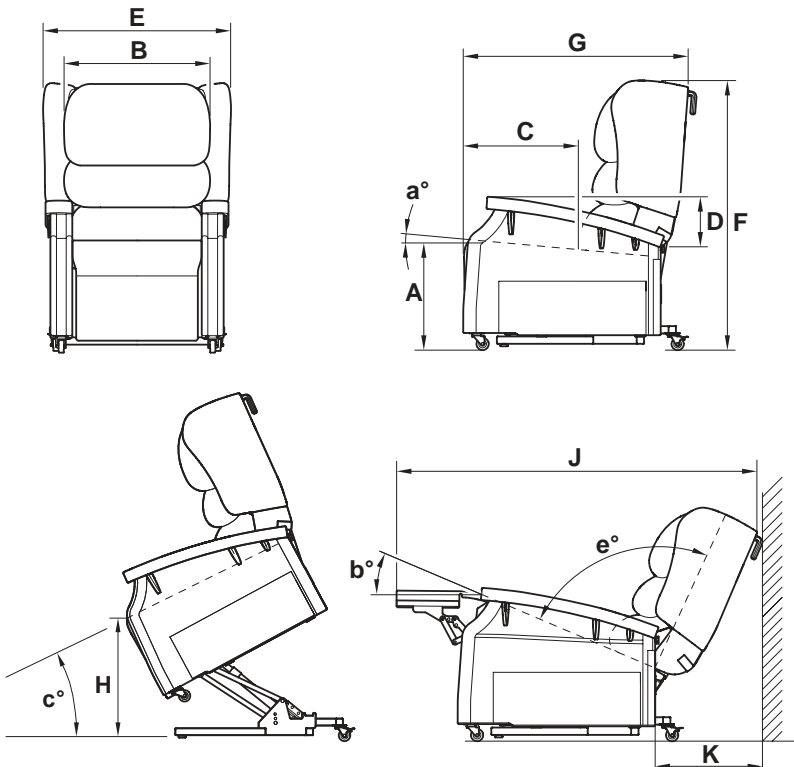

Figure 23 - Configura® Comfort 1 Dimensions



Double Insulated



Complies with the European Medical Device Regulation 2017/745



Important, Refer to Instructions For Use



Indoor Use Only



Manufactured By



Do not dispose of in domestic refuse



CAUTION: Risk of Electric Shock



EC Representative



Complies with the Medical Devices Regulations 2002 as amended



Medical Device in accordance with EU Medical Device Regulation 2017/745

Guarantee

17

The warranty period for the Configura® Comfort 1, Lite 2 and Mediatric Chair is 24 months, covering parts and labour only. We require a purchase order for any parts despatched, warranty or otherwise. Any issues regarding warranty should be addressed in the first instance to your supplier.

GUARANTEE

Regulation & Standards

18

Accora Ltd is committed to deliver safe products to our customers and has a policy of continuous improvement.

In order to achieve this commitment, the following regulation and standards have been followed.

- Medical Devices Regulation 2002 as amended
- Medical Device Regulation 2017/745
- BS EN ISO 14971 Medical devices - Application of risk management to medical devices.

STANDARDS

Contact Details

19

If you need further information, please contact us at:

Accora Ltd

Charter House
Barrington Road
Orwell
Cambridge
SG8 5QP

Tel: +44 (0) 1223 206100

E-mail: info@accora.care

Web address: www.accora.care

CONTACT DETAILS

Leave this page blank

Leave this page blank

Accora



Accora Ltd

Barrington Road, Orwell,
Cambridge, SG8 5QP
United Kingdom

T: +44 (0)1223 206100
info@accora.care
www.accora.care
